

V-Groove 6" Panel

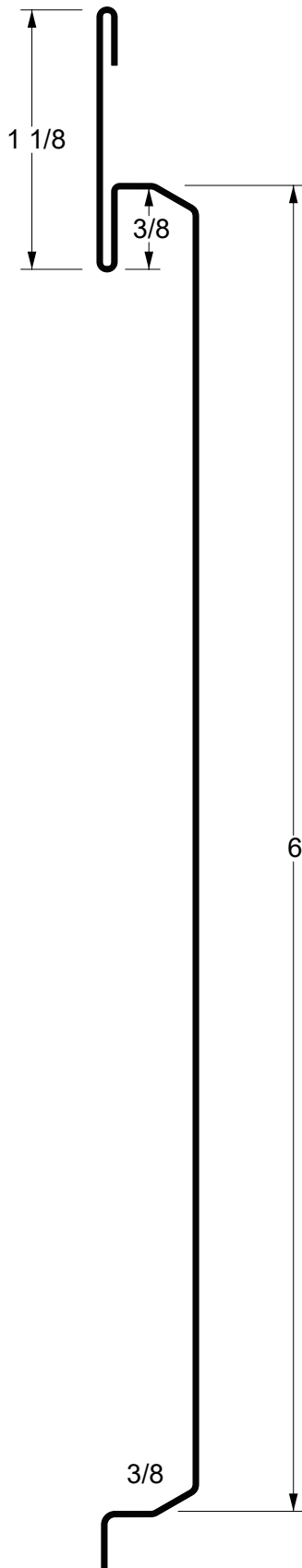

V-Groove 4" Panel

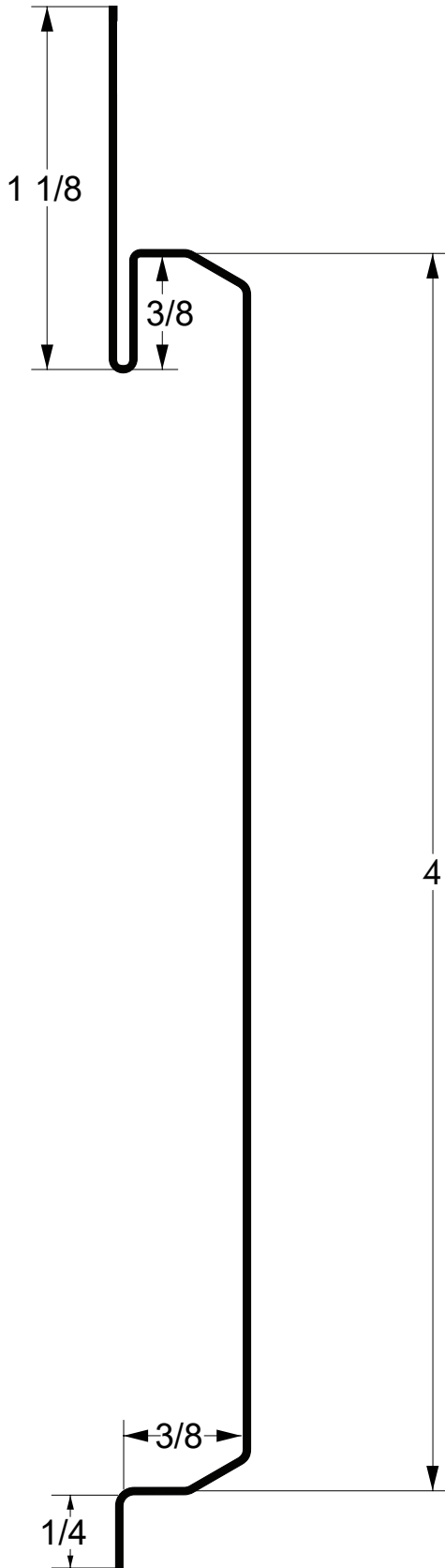

V-Groove Vented 4" Panel

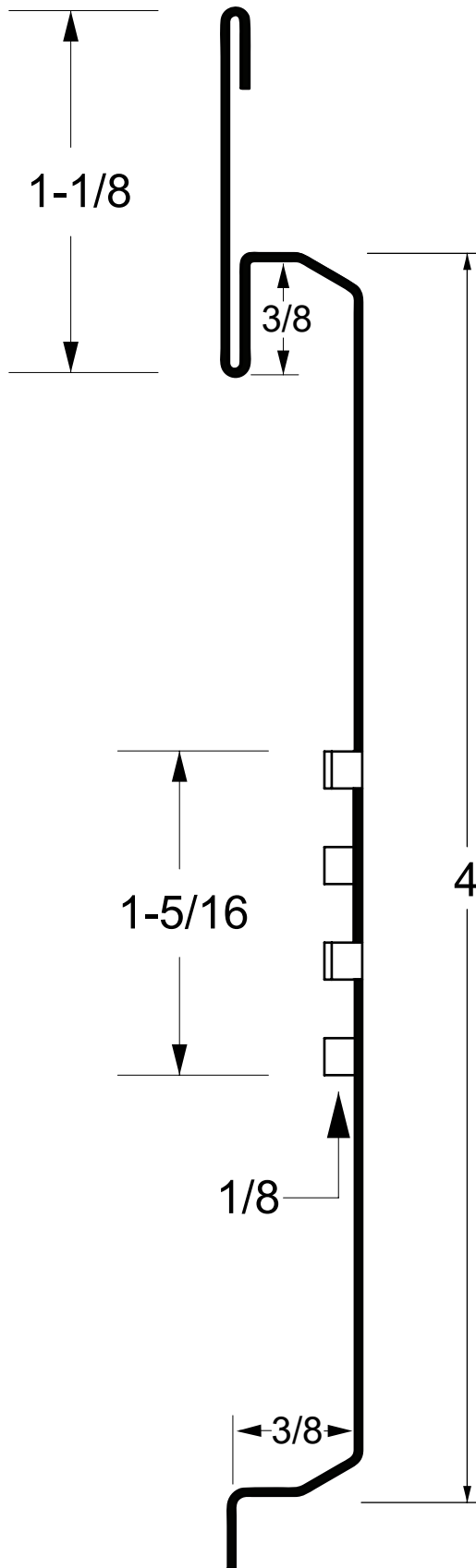

Provides 8.064 SQ. Inches of Venting per square foot

Double 7 - Two Panel Vented Soffit

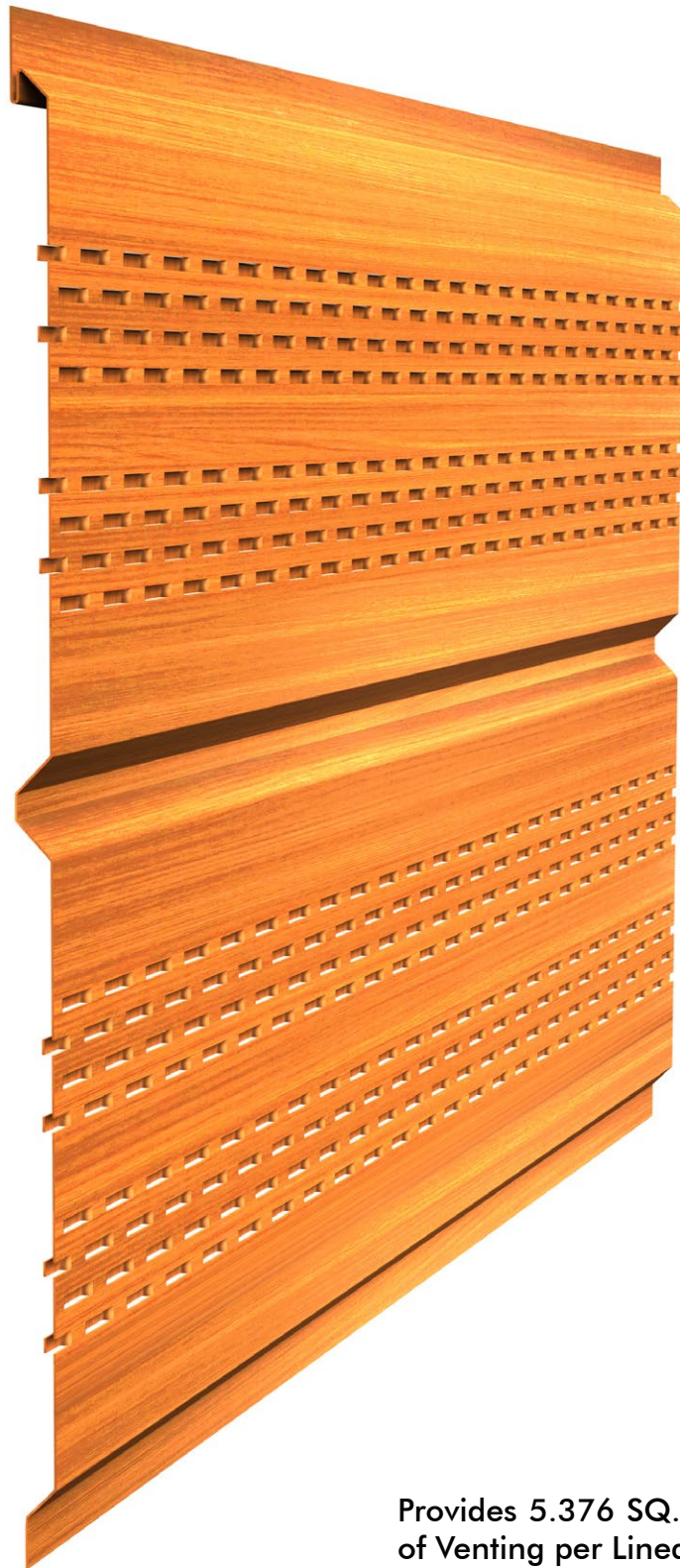
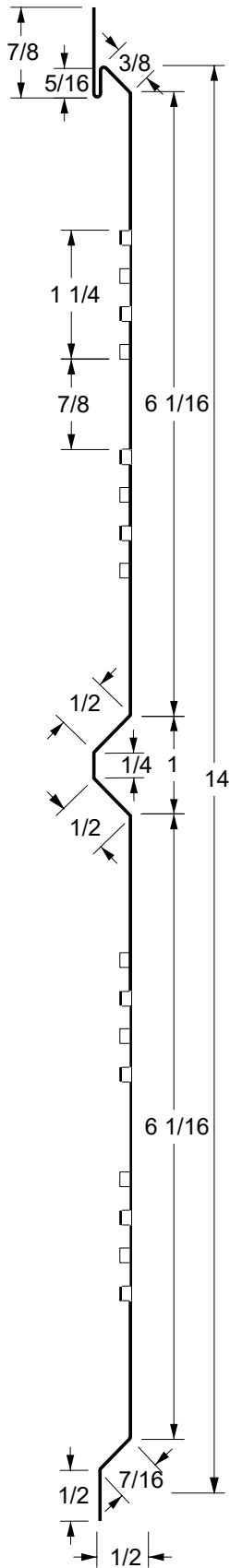

Provides 5.376 SQ. Inches of Venting per Linear Foot.
 Provides 4.6 SQ. Inches of Venting per Square Foot.

Double 7 - Two Panel Smooth Soffit

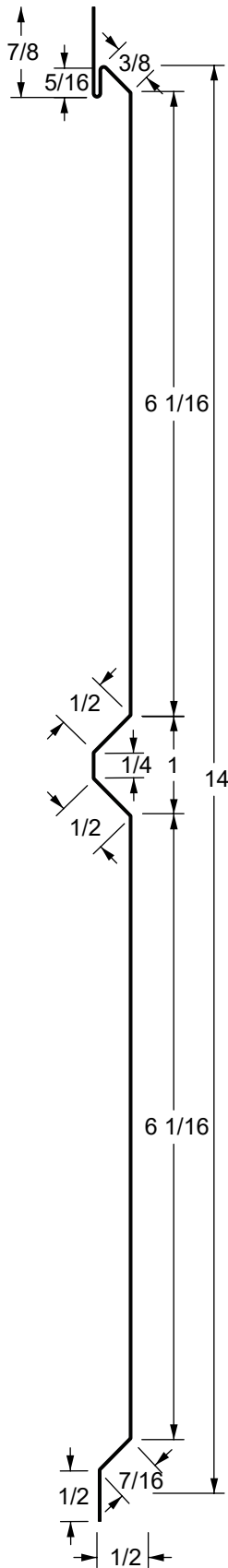

Starter Strip #701

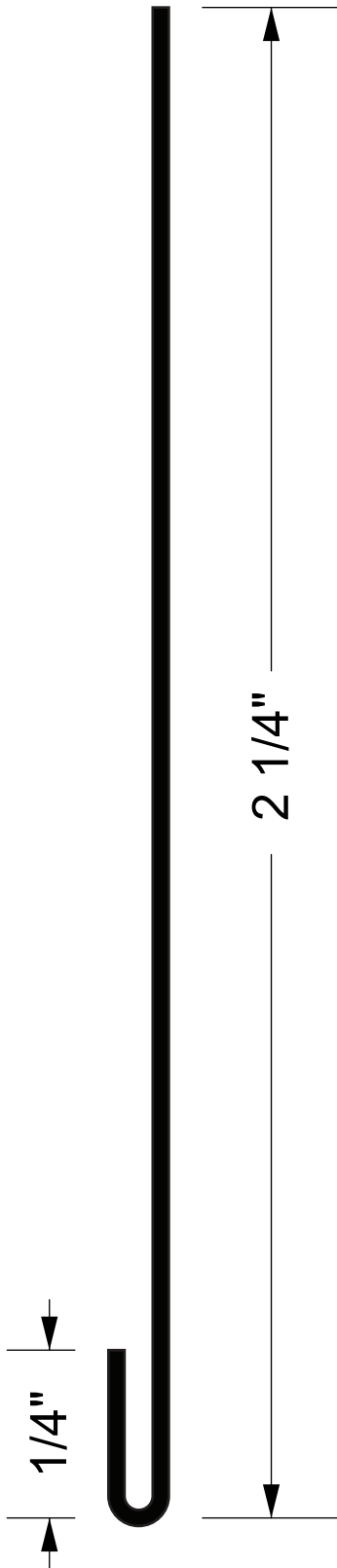

Base Trim #702

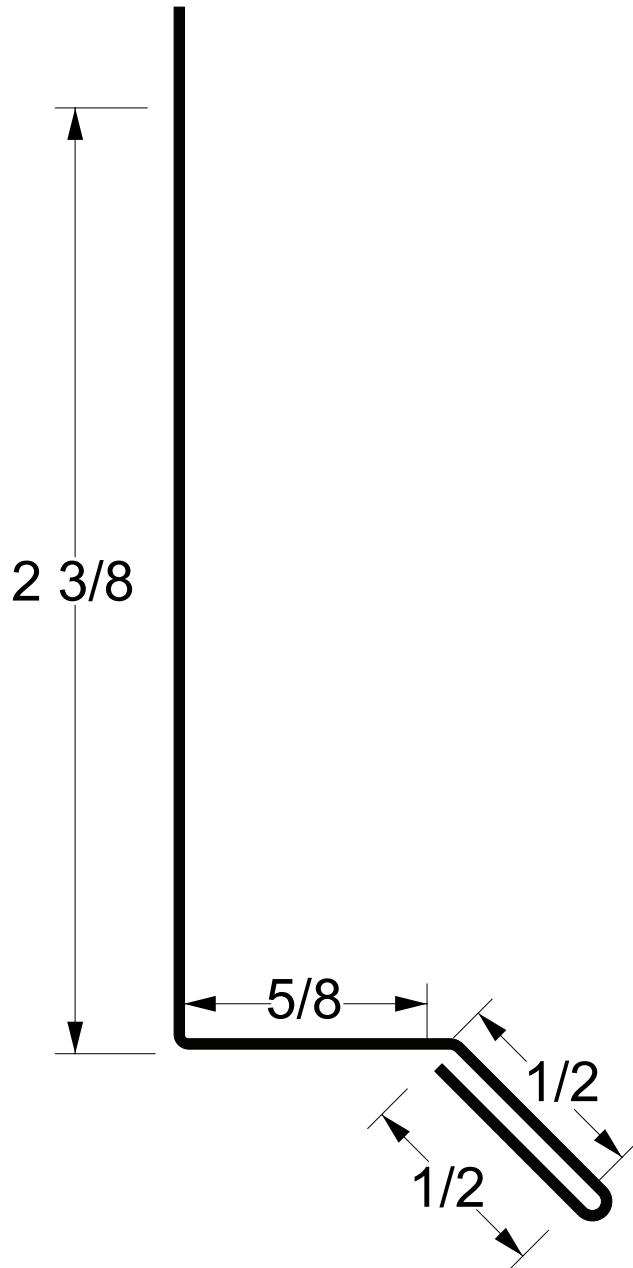

J Channel #703

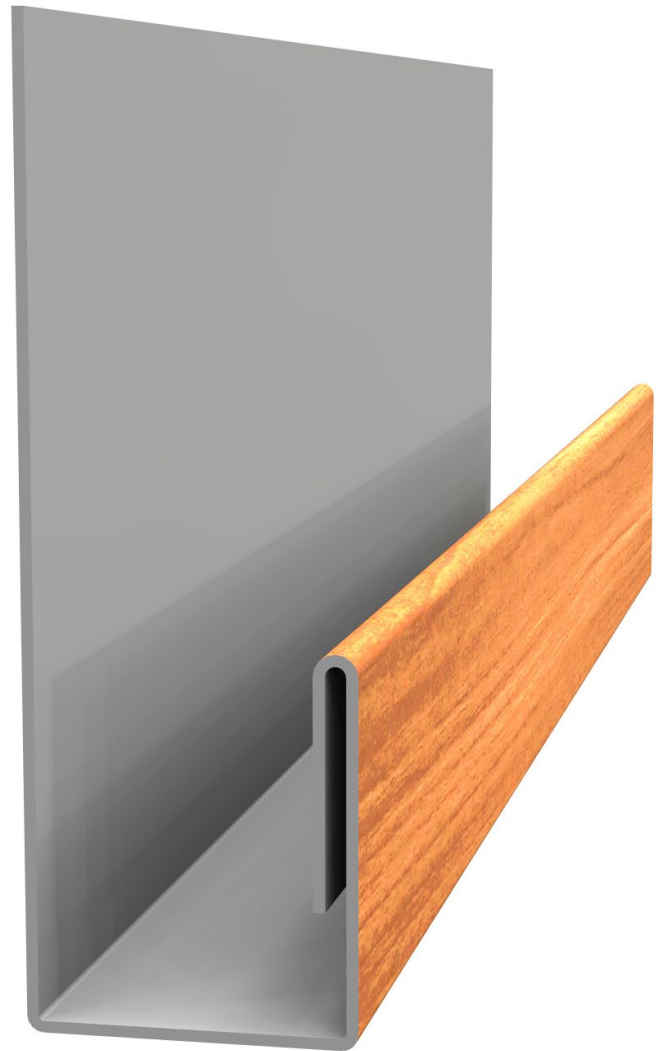
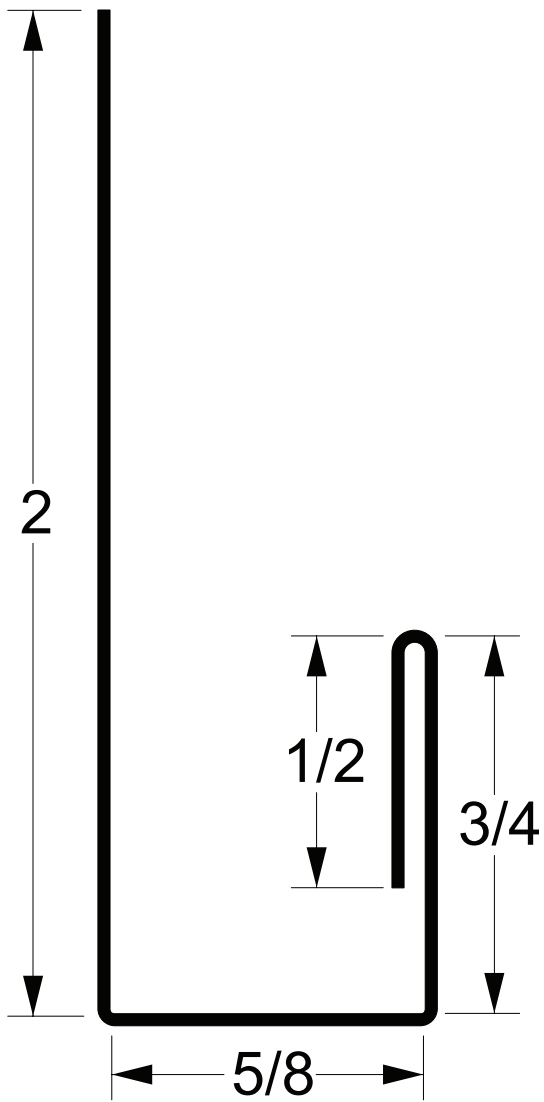

Top J Channel Insert #704

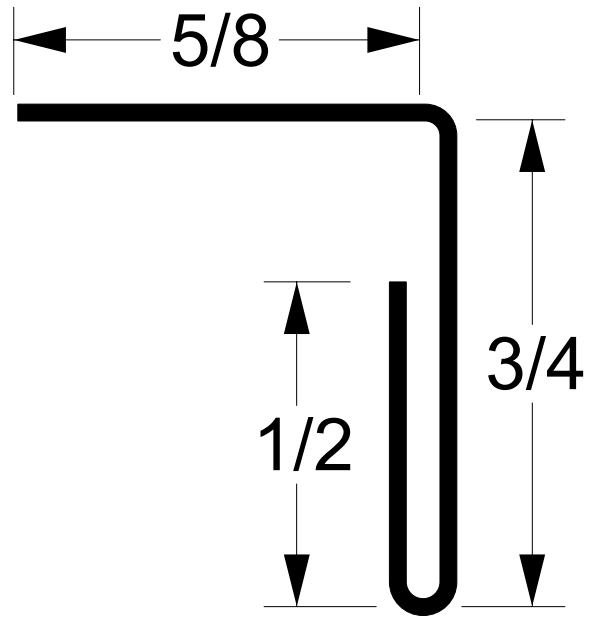

Hidden Closure #705

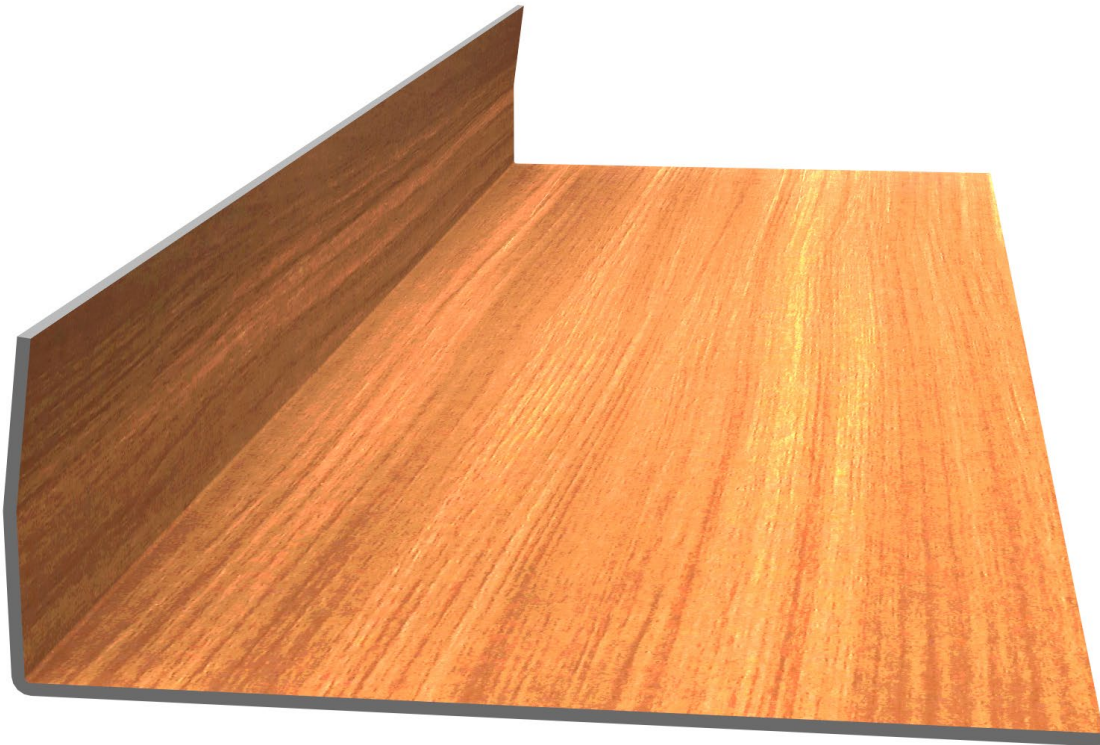

Outside Corner #706

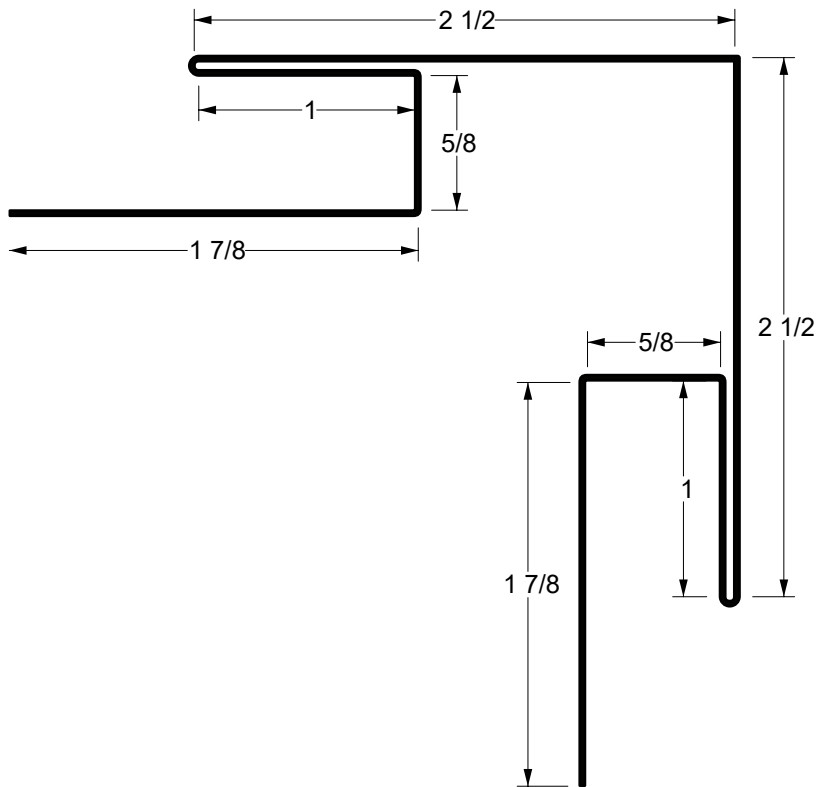

Inside Corner #707

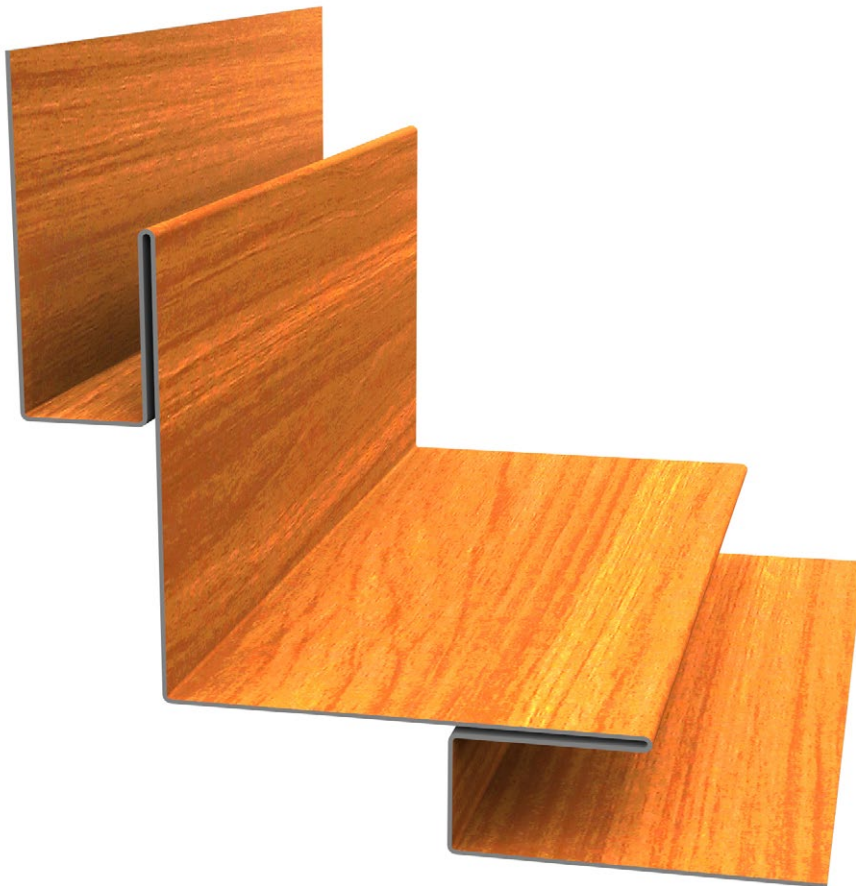
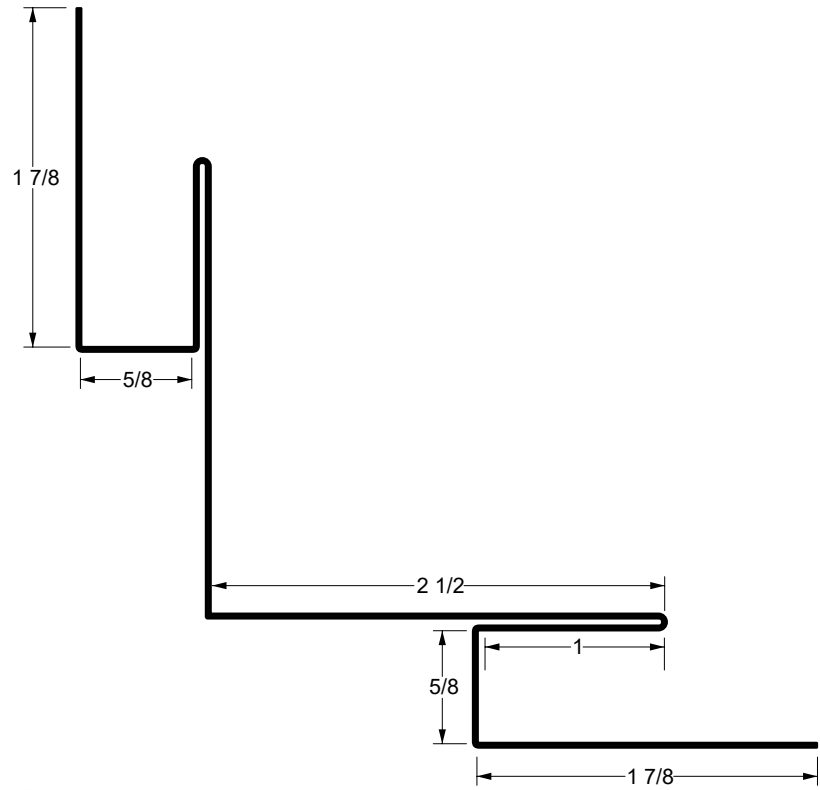

Joiner J #708

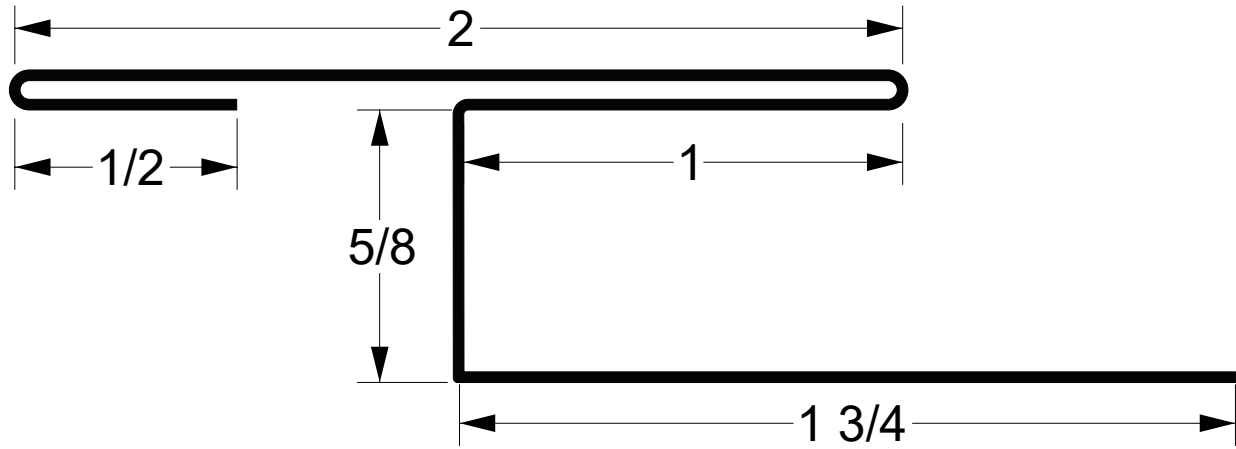

Drip Cap #709

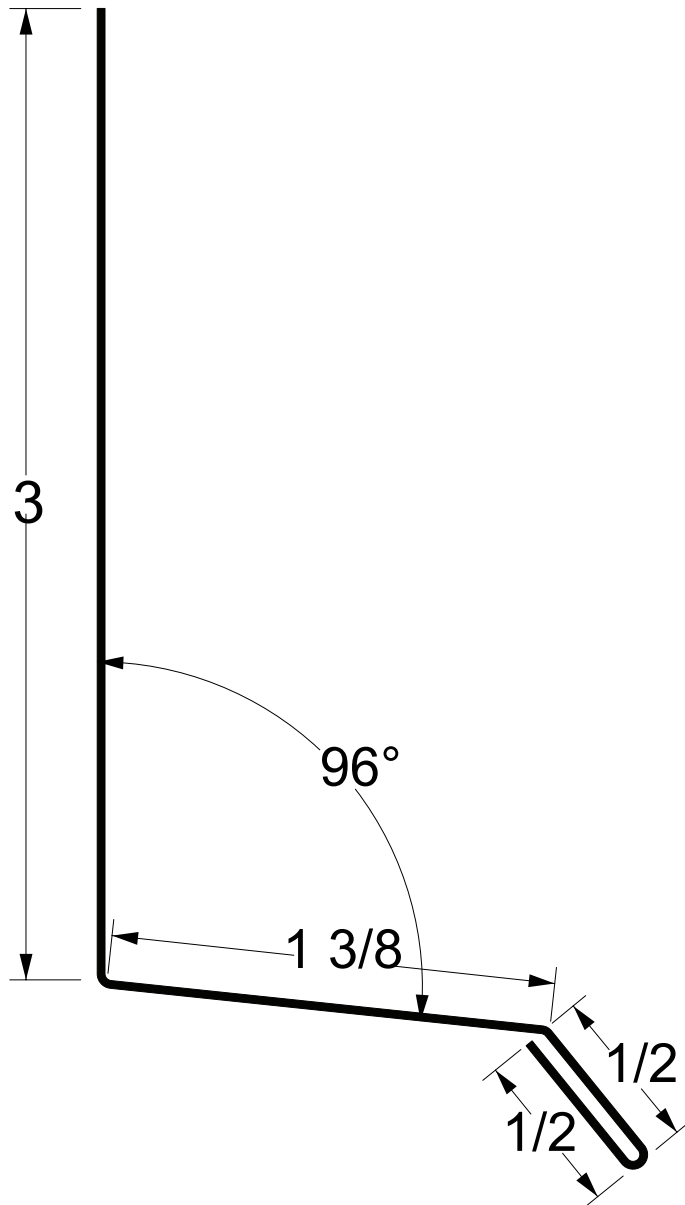

Window Batten #710

*Window Batten can be made in any width from 3" to 6"

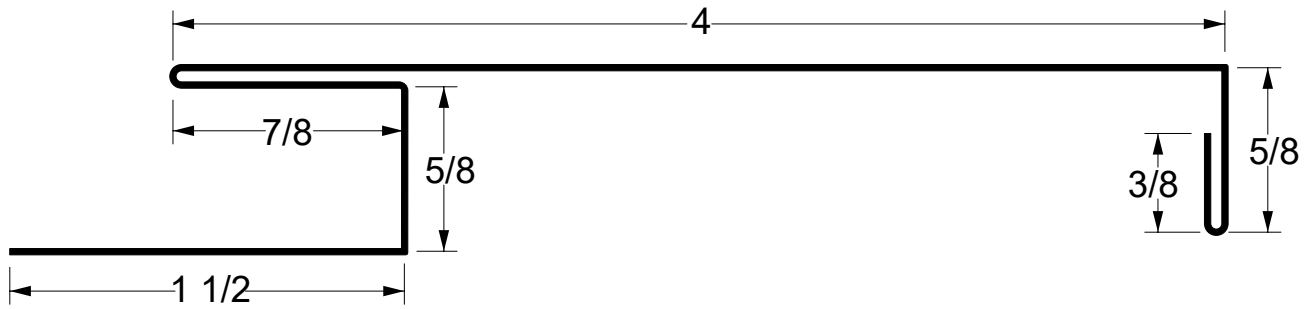

Open Outside Corner #711

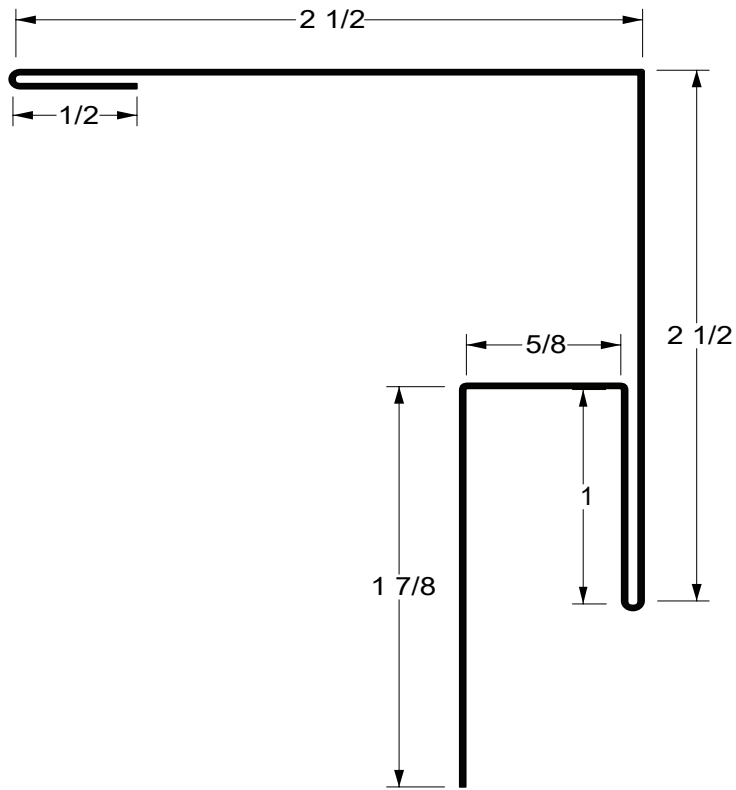

Open Inside Corner #712

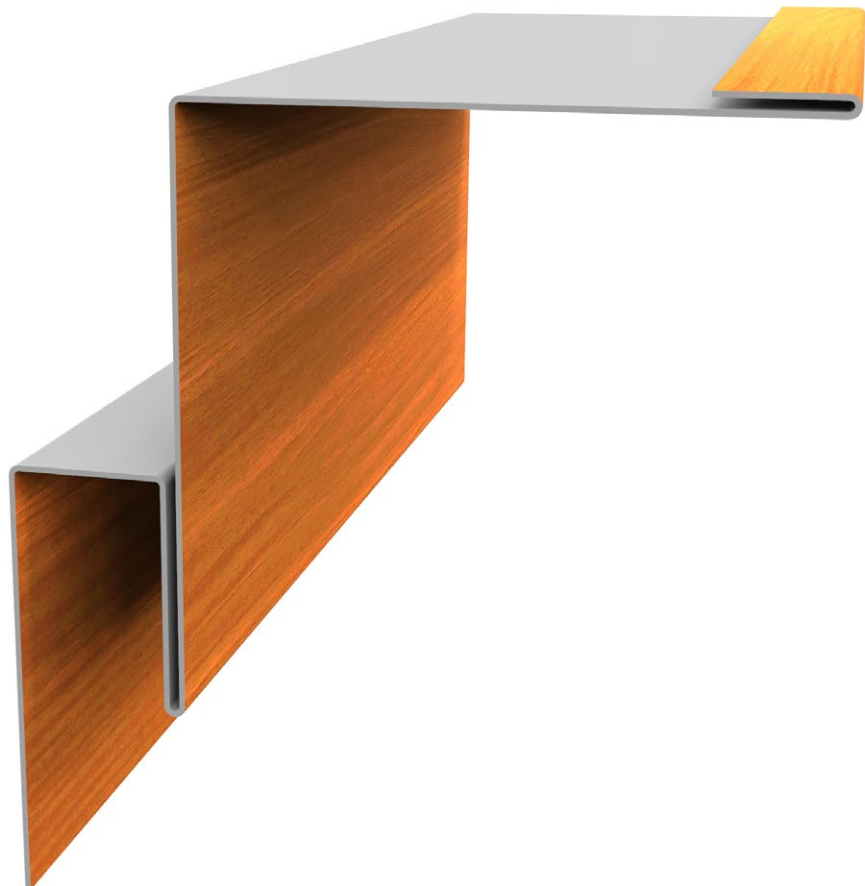
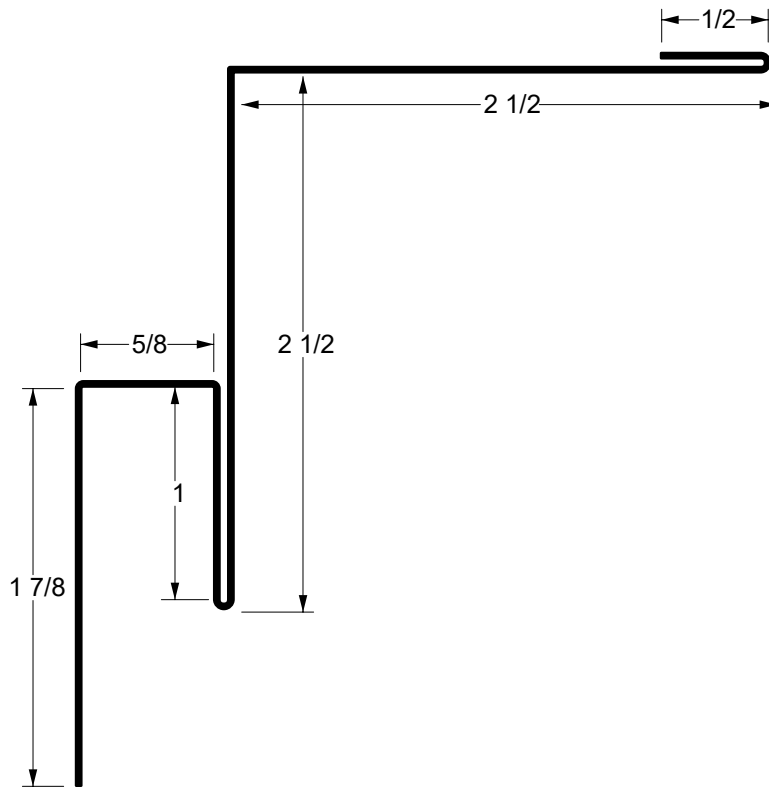

Bottom J Receiver #713

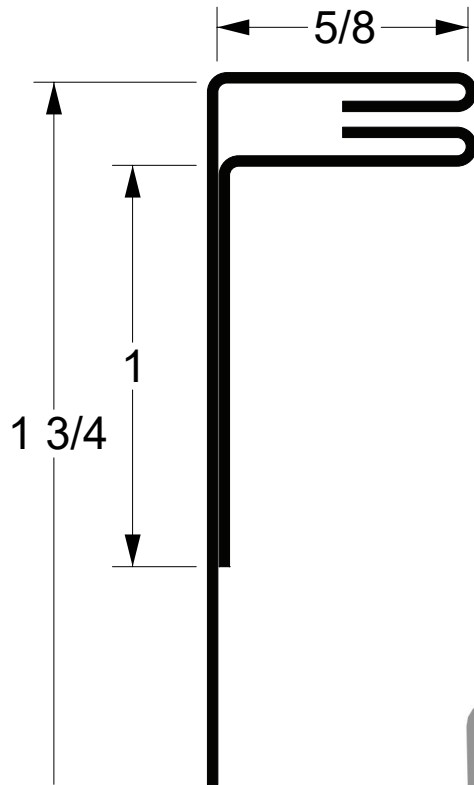

Snap-T Outside Corner #714

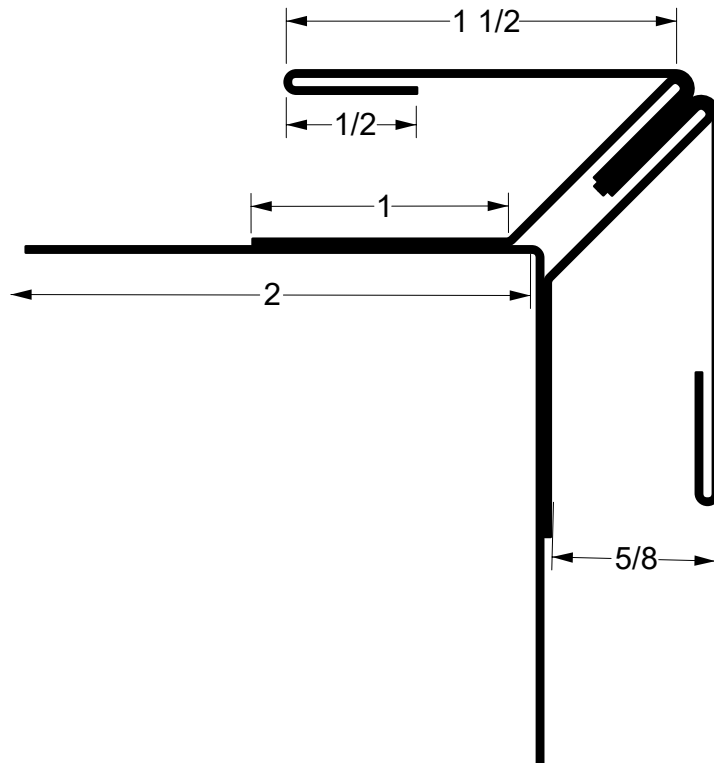

Two Piece J-Channel #715

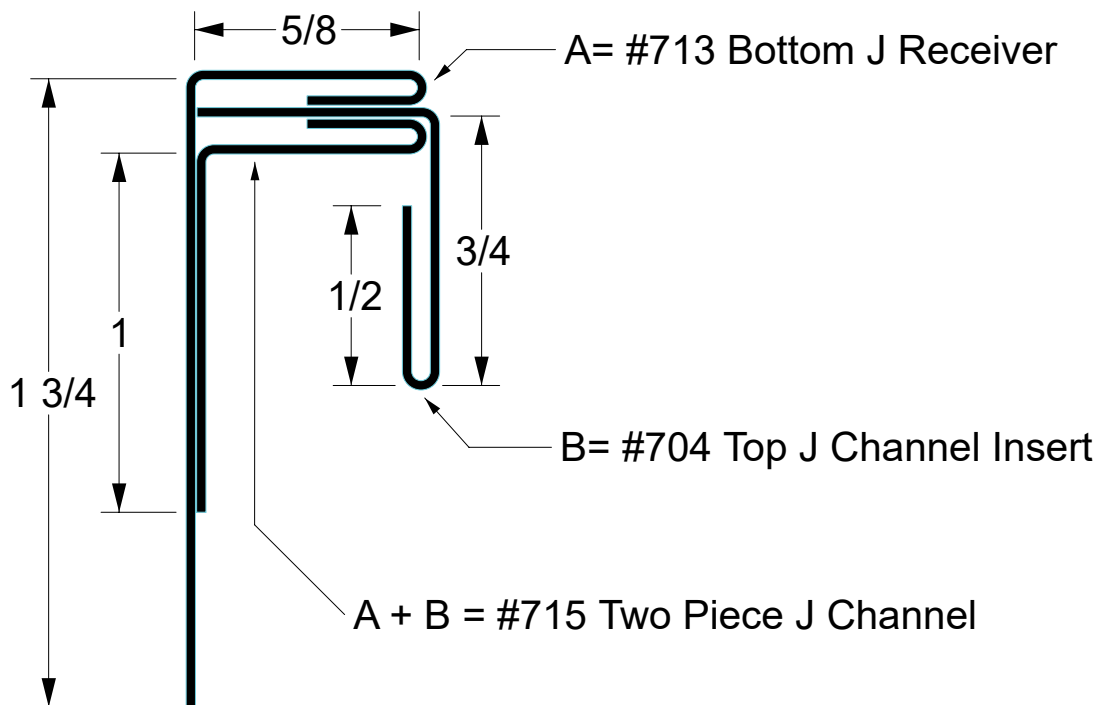

Joiner J Insert #716

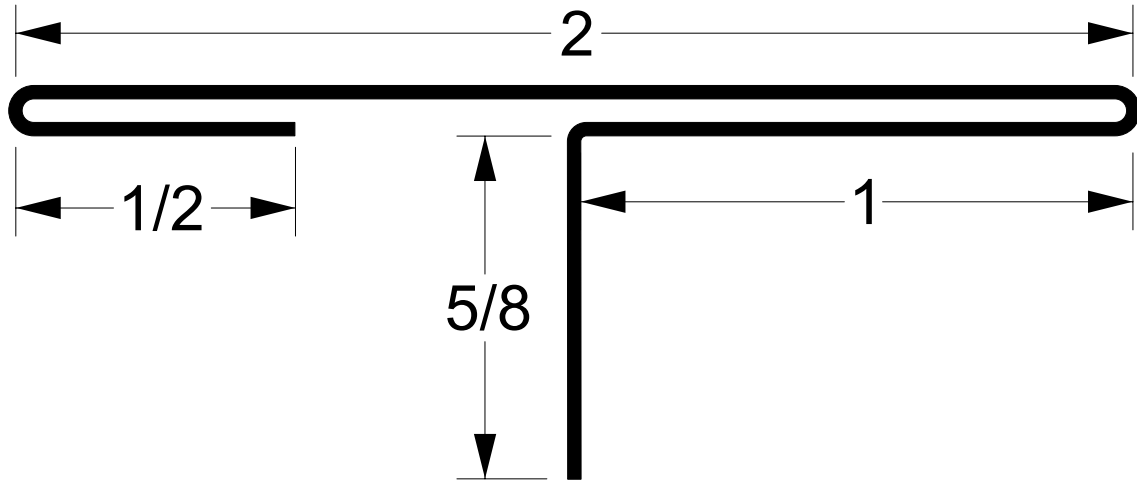

Snap-T Inside Corner #717

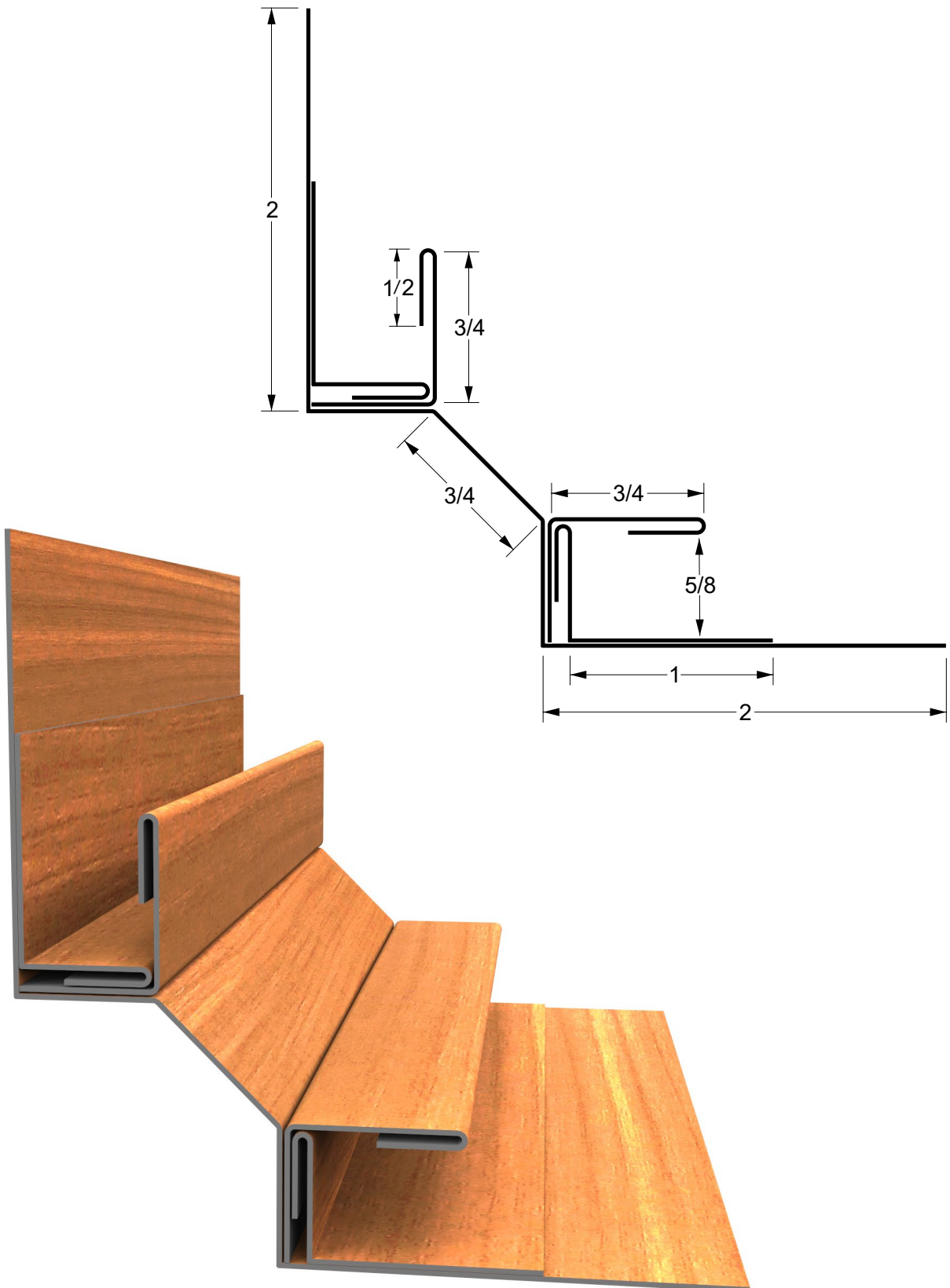

Two Piece Joiner J #718

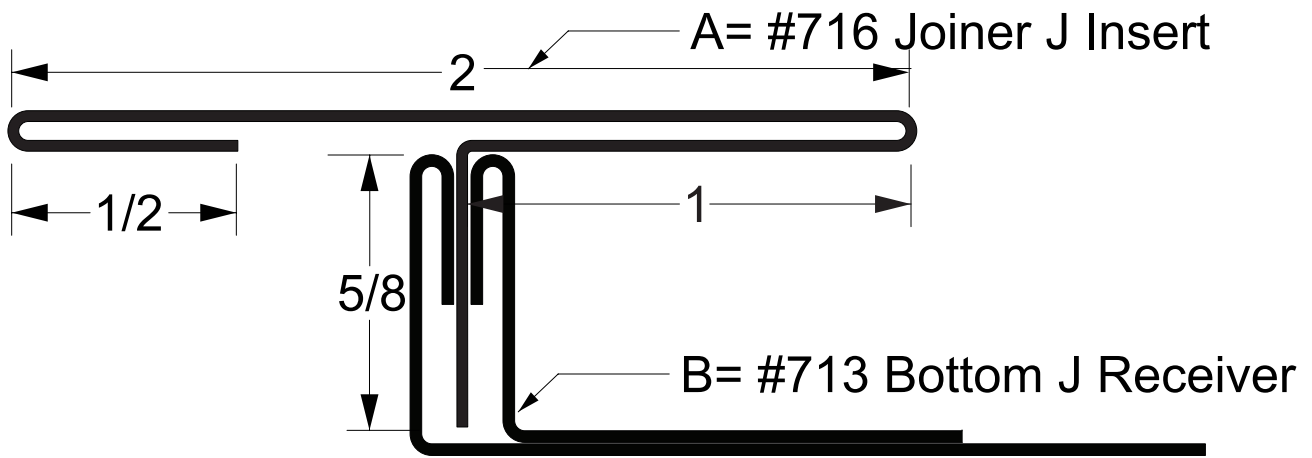

A+B = #718 Two Piece Pocket Joiner J



Snap-T Outside Corner Insert #723

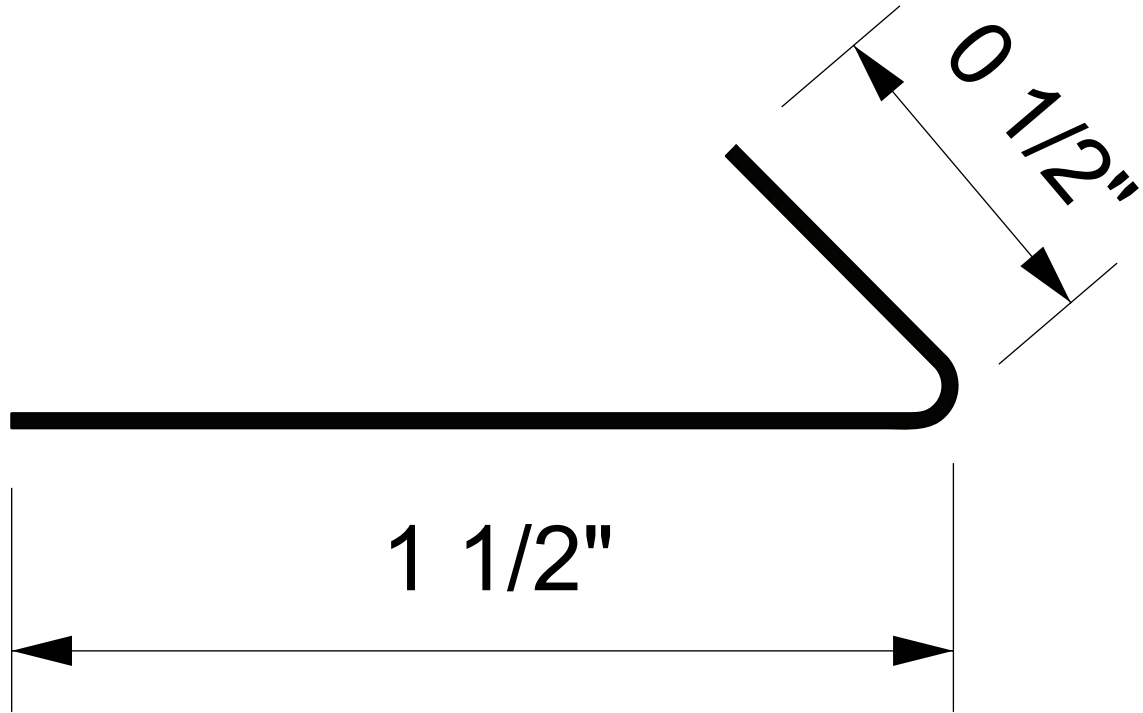

Snap-T Outside Corner Base #724

